

GT300



Advanced High-Definition CBCT Imaging

Genoray America



A Perfect Balance of Comfort and Performance

Voice Guidance System :
Provides a soothing atmosphere for patients
(Multilingual Support)

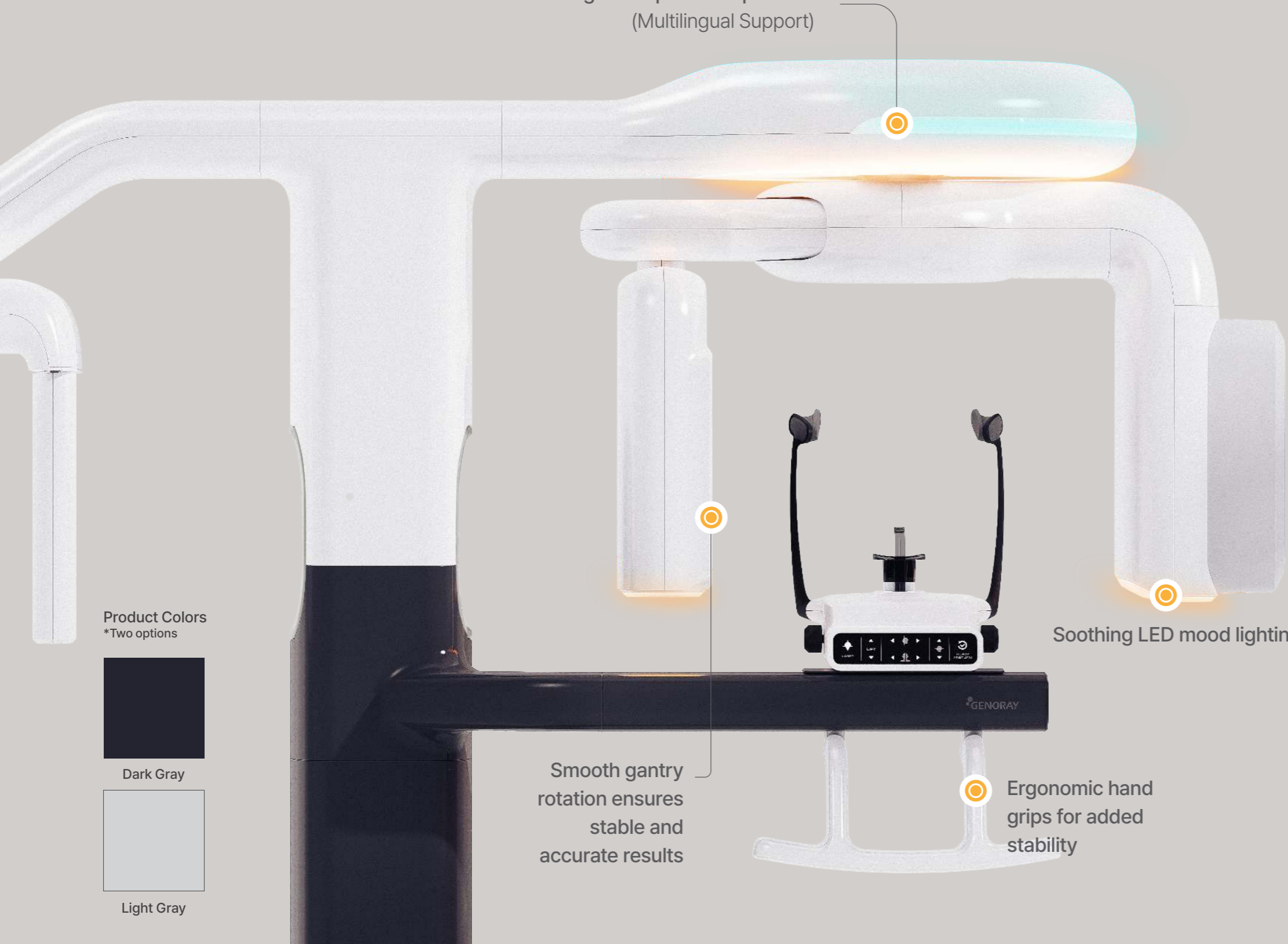

Product Colors
*Two options



Dark Gray

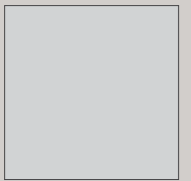

Light Gray

Soothing LED mood lighting

Smooth gantry rotation ensures stable and accurate results

Ergonomic hand grips for added stability

Precise Diagnostic FOV Options

Versatile 5x5 and 11x11 FOVs for precise and comprehensive imaging

Enhanced Safety & Advanced Imaging

Pulsed mode provides high-quality imaging with low-dose exposure for patient safety

Smart Positioning

Automatically saves patient positioning data for quick and hassle-free repositioning during follow-up visits



Initial Measurement of Patient Data

Storing Patient Data

Automatic Positioning on Return Visits

Dark Gray

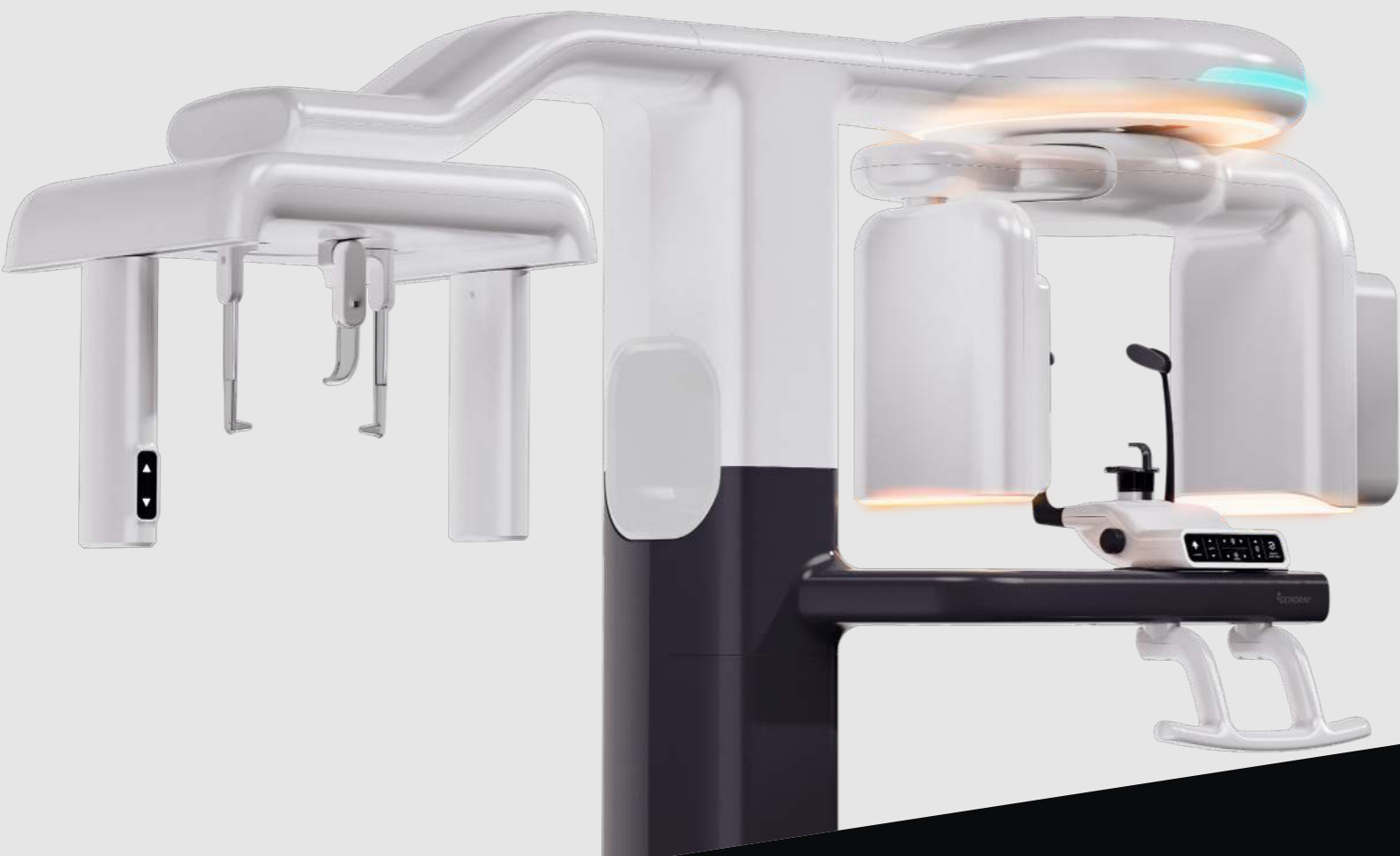

Light Gray

CBCT

Provides essential FOV options to meet your diagnostic needs

Multiple FOV Sizes with High Resolution

Optimize imaging quality with significantly reduced radiation exposure.

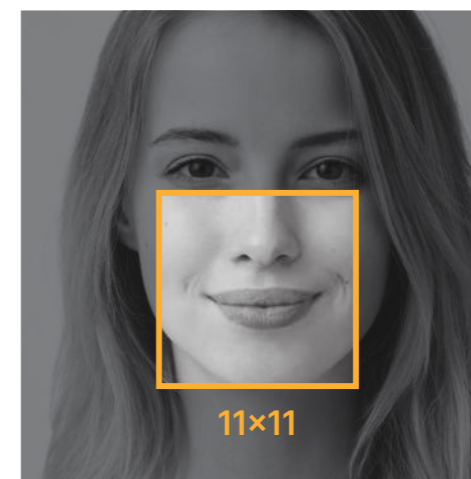
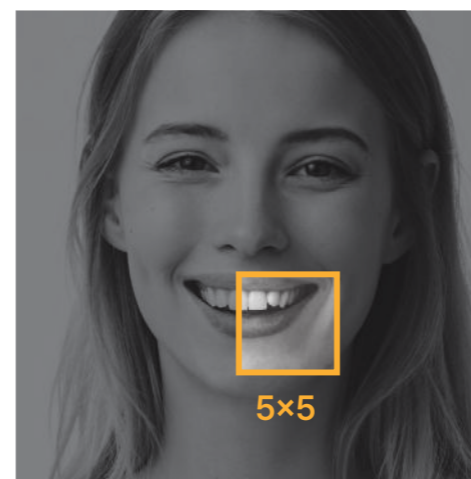

Endo	Teeth
5x5	11x11
65 μ m	140 μ m

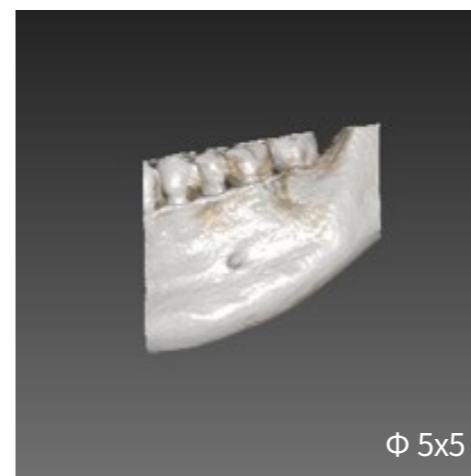

Automation that elevates diagnostic and treatment precision and efficiency.

Intelligent Diagnostic Assistance

Auto Nerve Detection

Automatically detects and visualizes the inferior alveolar nerve canal to improve diagnostic efficiency and safety.



Auto TMJ

Automatically analyzes and visualizes the temporomandibular joint (TMJ), enabling fast and precise diagnosis.



Auto Arch

Automatically creates the dental arch line to improve workflow efficiency and accuracy.



Auto Tracing *Optional

Automatically identifies key cephalometric landmarks to support fast and accurate treatment planning.

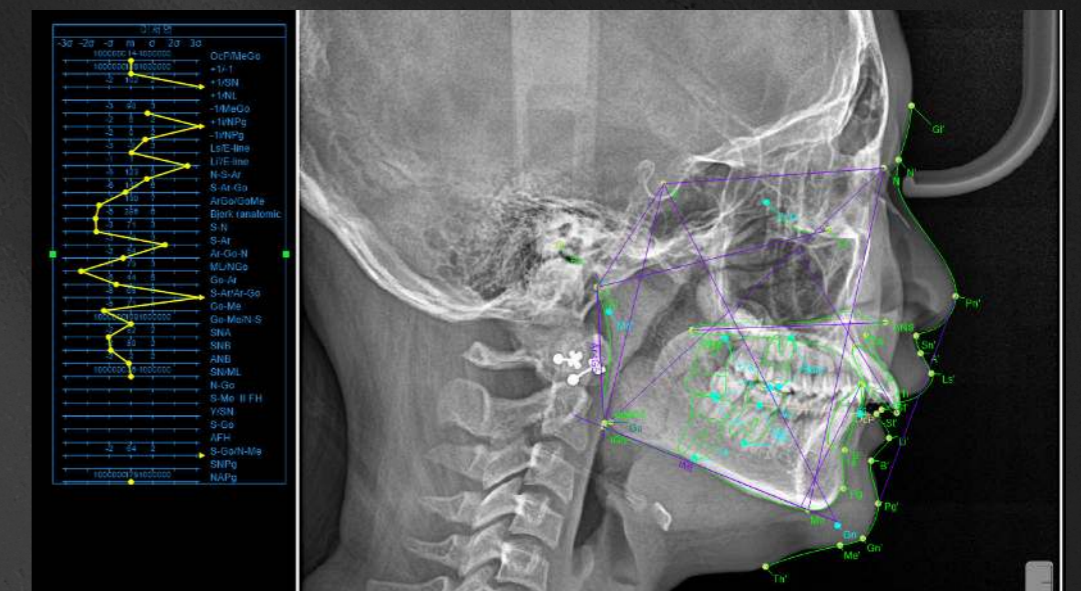

Cephalometric & Panoramic

With Genoray's patented design,
we provide accurate and
distortion-free Cephalometric images

High-Precision Cephalometric Imaging

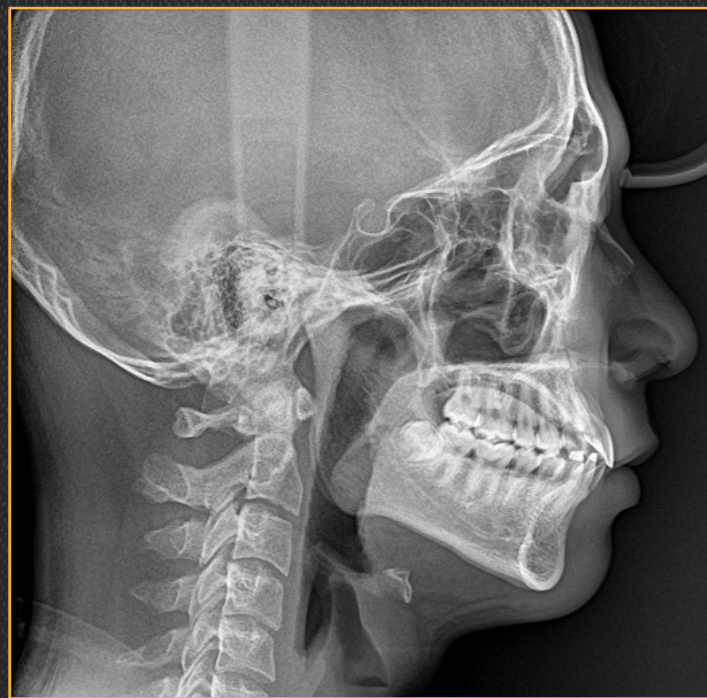

Normal mode

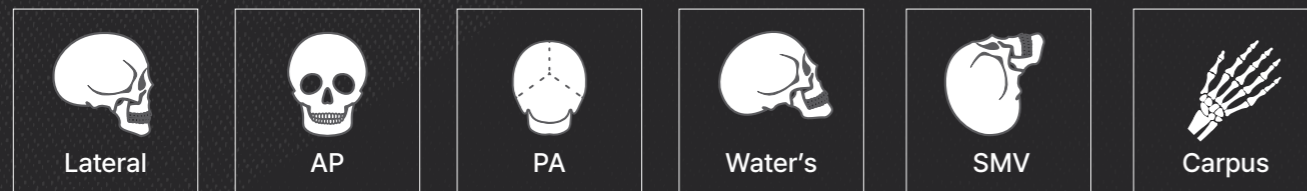

Normal Mode / Standard Panoramic / TMJ Lateral Double / Submento Vertex and Carpus

Various Panoramic Exposure Modes

Standard, Orthogonal, Bitewing, TMJ (Lateral, PA, LAT-PA), and Sinus (Lateral, Lateral Mid, PA)



Standard panoramic



Bitewing

TMJ lateral double

Operation S/W

GT300's redesigned UI enhances usability and workflow efficiency.

Theia S/W

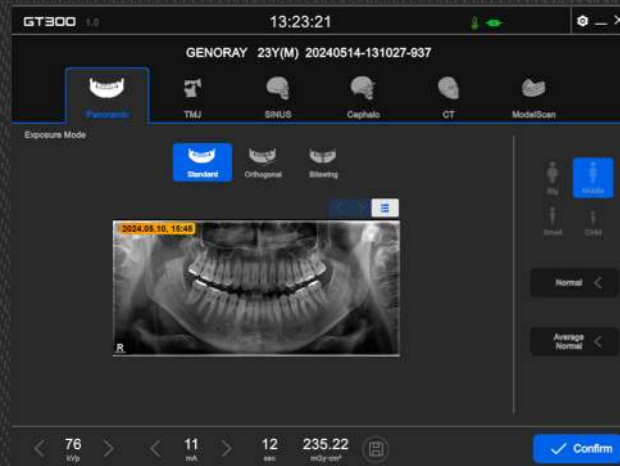

Auto-positioning function



Cephalo mode

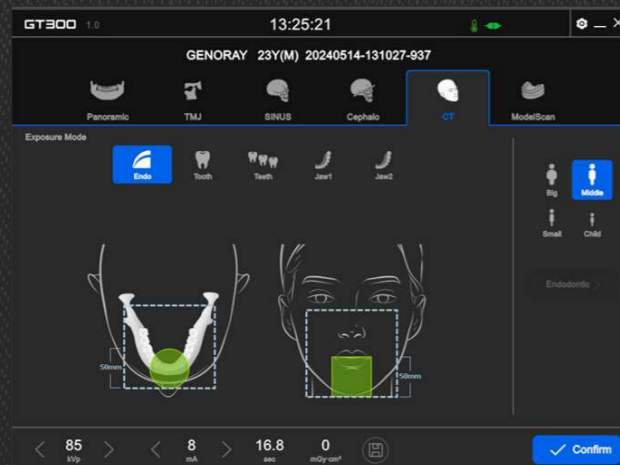

CT mode



Model-scan mode

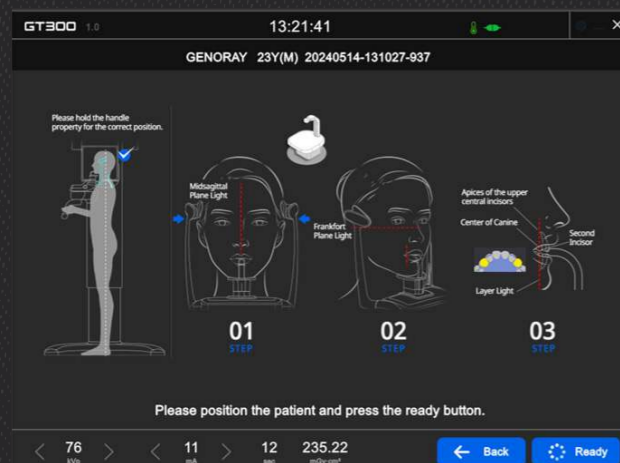

Pano positioning guide



Ceph positioning guide

Genoray's 3D imaging software for precise diagnostic imaging

Theia

View all information at a glance with the thumbnail layout. Fast access to image viewing and acquisition.



Real-time Image Processing

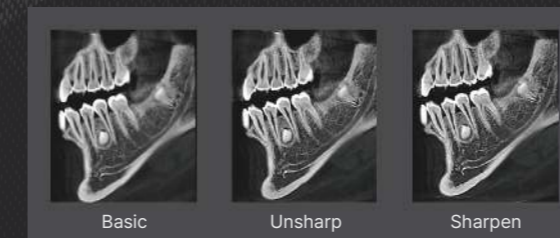

Real-time image processing available with check box tool

Clipping

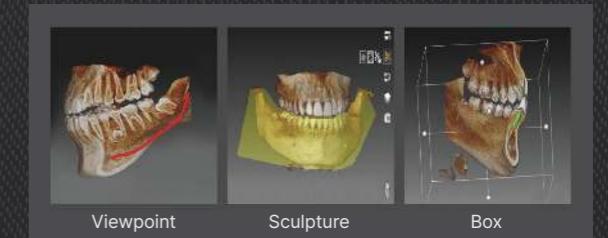

Provides excellent cross-sectional views in the desired direction with high-quality volume rendering.

AI Layout Customization



Flexible layout customization with simple drag-and-drop functionality.



Supports up to 9 images

Improved image processing

Enhanced Image Processing SMARF reduces metal artifacts from prosthetics for clearer diagnostic images.

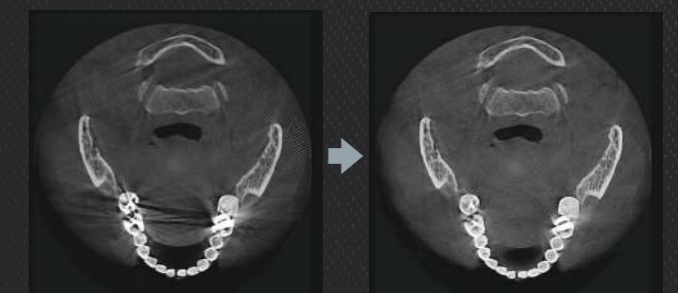

STL Export

Converts 3D images into STL data for use with 3D printers and CAD/CAM systems.

General Specifications

Items	FOV/ROI (mm)	Image Size (max, mm)	Voxel (μm)	Detector		Exp. Time (sec)
				Pitch (μm)	Size (mm)	
CT	50 × 50 ~ 110 × 110	-	65 ~ 300	100 × 100	179.2 × 179.2	1.75 ~ 16.8
Cephalometric	-	316.35 × 227.25	-	75 × 75	227.25 × 6.45	2 ~ 15.5
Panoramic	-	332.1 × 150.4	-	100 × 100	150.4 × 8	2 ~ 17
Focal Spot	0.5mm					
Target Angle	5°					
Tube Voltage	60 ~ 90 kV					
Tube Current	4 ~ 12 mA					
Line Voltage	100 ~ 240 VAC, 50/60 Hz					

Dimensions

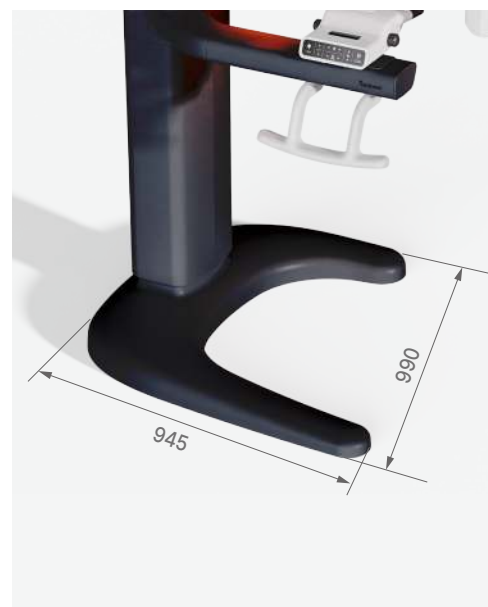
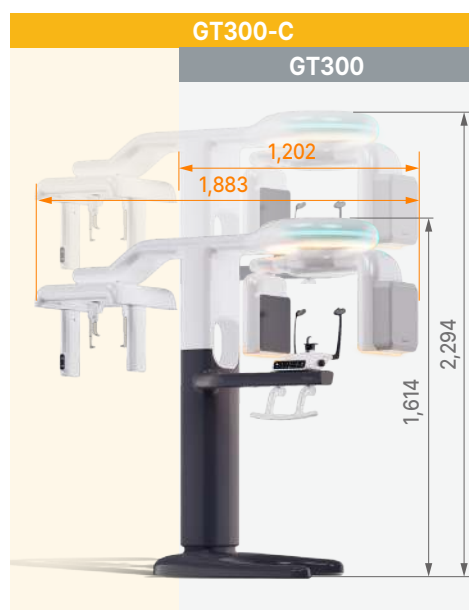

GENORAY Co.,Ltd.

T +82-31-5178-5500
E genoray@genoray.com
W www.genoray.com

GENORAY EU GmbH

T +49-30-50969498
E info@genorayeuropa.com
W europe.genoray.com

GENORAY Türkiye

T +90-216-463-57-37, +90-216-463-57-53
E genorayturkiye@genoray.com
W turkiye.genoray.com

GENORAY America Inc.

T +1-855-436-6729
E inquiry@genorayamerica.com
W www.genorayamerica.com

GENORAY Japan

T +81-45-620-4971
E Info@genorayjapan.co.jp
W www.genorayjapan.co.jp

GENORAY Shanghai

T +86-021-6785-8538
E genoraychina@genoray.com
W www.genoray.com.cn